



ENTRY LEVEL tilt sensor with MEMS technology.

Space-saving solution, high performances, easy installation.

High IP protection level, resistance to shock and vibration, and high electromagnetic compatibility make this product suitable for many mobile hydraulics applications.

Developed to ensure a robust and high-performance solution for applications such as agricultural machines, construction machines, material handling equipments.

### TECHNICAL DATA

#### Measurement range

$\pm 10^\circ \pm 15^\circ \pm 20^\circ \pm 30^\circ \pm 45^\circ \pm 60^\circ \pm 85^\circ$  (single axis Z for analogue output-dual axis XY)  
 $360^\circ (\pm 180^\circ)$  single axis Z only

#### Supply voltage

+5Vdc (only for 0.5...4.5Vdc output); +10...+36Vdc (see output signal for right supply voltage)

#### Output signal

0.5...4.5Vdc RATIOMETRIC (supply +5Vdc); 0.5...4.5Vdc; 0...10Vdc; 4...20mA; CANopen

#### Electrical connections

AMP Superseal 6P 282108-1; cable output - PUR sheath conductors AWG 22;  $\varnothing 4.4$  (single) -  $\varnothing 5.5$  (redundant); cable output + M12 5 pin male overprinted connector

#### Resolution

12 bit (analog output); 0.01 deg (CANopen output)

#### Accuracy (Factory verification @ 25 °C)

$< \pm 0.5\%$  FS

#### Working temperature

-40... +85 °C

#### Temperature coefficient at 0-deg inclination

Typical  $< \pm 0.006$  deg/°C

#### Long term repeatability

Single axis: Typical  $< \pm 0.5$  deg in the range  $\pm 180$  deg  
 Dual axis: Typical  $< \pm 0.5$  deg in the range  $\leq \pm 60$  deg,  $\pm 2$  deg otherwise

#### Vibrations

20g 10 Hz ... 2000 Hz IEC 60068-2-6

#### Shock

Impulsive on 3 axes; 50g 11 ms IEC 60068-2-27

#### Electromagnetic compatibility

2014/30/EU Electromagnetic Compatibility (EMC)

#### IP protection level

IP67 - IPX9K with female mating connector mounted AMP282090-1(GIB-A version);  
 IP67 - IPX9K(GIB-F cable-PUR version);  
 IP67 with female homologated connector mounted, tightening torque 0.6Nm + low strength threadlocker (GIB-F cable+M12 connector version)

#### Housing material

PBT

### MECHANICAL DIMENSIONS

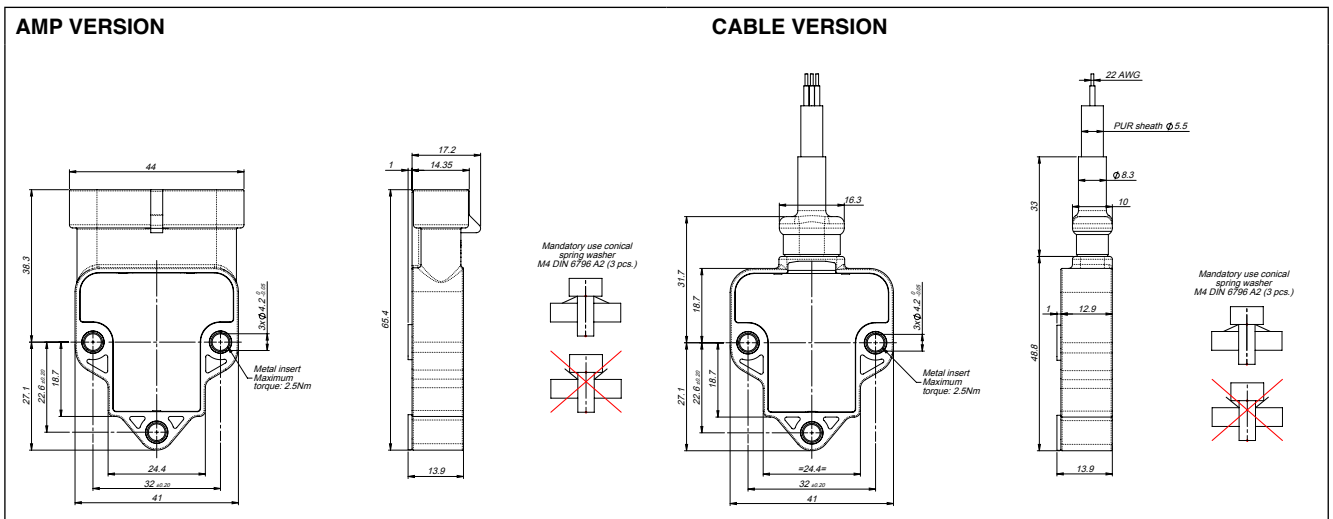

# ELECTRICAL CONNECTIONS

## AMP VERSION

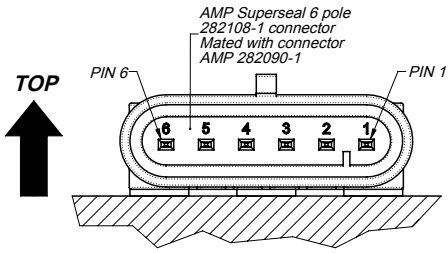

### ANALOG CONNECTIONS DUAL AXIS X-Y

1. GROUND
2. + SUPPLY
3. OUTPUT X
4. OUTPUT Y
5. n.c.
6. n.c.

### ANALOG CONNECTIONS SINGLE AXIS Z

1. GROUND
2. + SUPPLY
3. OUTPUT Z
4. n.c.
5. n.c.
6. n.c.

### CAN CONNECTIONS SINGLE/DUAL AXIS

1. GROUND
2. + SUPPLY
3. n.c.
4. n.c.
5. CAN L
6. CAN H

ITEMS MARKED "n.c." MUST NOT BE CONNECTED

### SINGLE AXIS

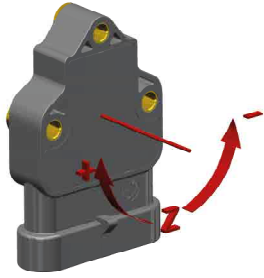

### DUAL AXIS

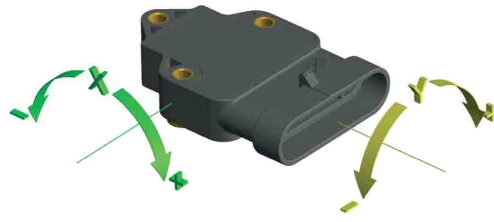

## CABLE VERSION

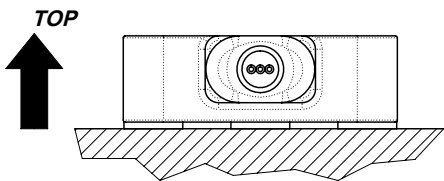

### ANALOG CONNECTIONS DUAL AXIS X-Y

- |        |          |
|--------|----------|
| BLACK  | GROUND   |
| RED    | + SUPPLY |
| YELLOW | OUTPUT X |
| GREEN  | OUTPUT Y |
| BLUE   | n.c.     |
| WHITE  | n.c.     |

### ANALOG CONNECTIONS SINGLE AXIS Z

- |        |          |
|--------|----------|
| BLACK  | GROUND   |
| RED    | + SUPPLY |
| YELLOW | OUTPUT Z |
| GREEN  | n.c.     |
| BLUE   | n.c.     |
| WHITE  | n.c.     |

### CAN CONNECTIONS SINGLE/DUAL AXIS

- |       |          |
|-------|----------|
| BLACK | GROUND   |
| RED   | + SUPPLY |
| BLUE  | CAN L    |
| WHITE | CAN H    |

ITEMS MARKED "n.c." MUST NOT BE CONNECTED

### SINGLE AXIS

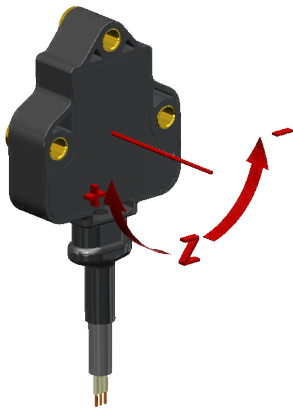

### DUAL AXIS

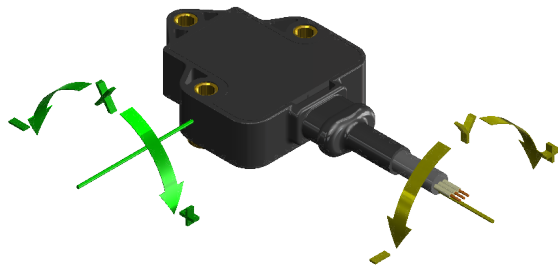

# CABLE+M12 VERSION

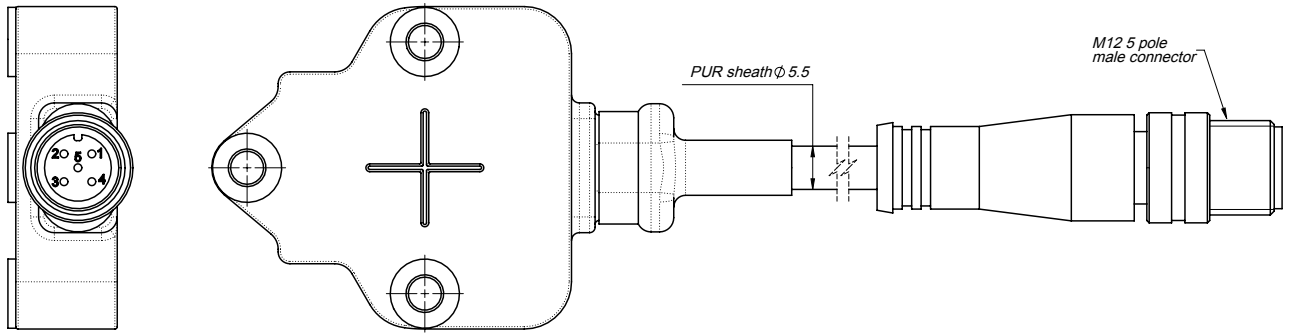

**ANALOG  
CONNECTIONS  
DUAL AXIS X-Y**

- 1. + SUPPLY
- 2. OUTPUT Y
- 3. GROUND
- 4. OUTPUT X
- 5. n.c.

**ANALOG  
CONNECTIONS  
SINGLE AXIS Z**

- 1. + SUPPLY
- 2. n.c.
- 3. GROUND
- 4. OUTPUT Z
- 5. n.c.

**CAN  
CONNECTIONS  
SINGLE/DUAL AXIS**

- 1. n.c.
- 2. + SUPPLY
- 3. GROUND
- 4. CAN H
- 5. CAN L

ITEMS MARKED "n.c." MUST NOT BE CONNECTED

## FULL REDUNDANT VERSION

Gefran GIB tilt sensor is designed to be double mounted with specific spacers (BUS027) in order to have a full redundant space-saving version.

Please pay attention how to install the two GIB sensors: please position them both always face up or both face down.

### Example of AMP FULL REDUNDANT VERSION

#### SINGLE AXIS

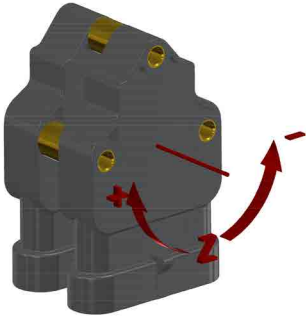

#### DUAL AXIS

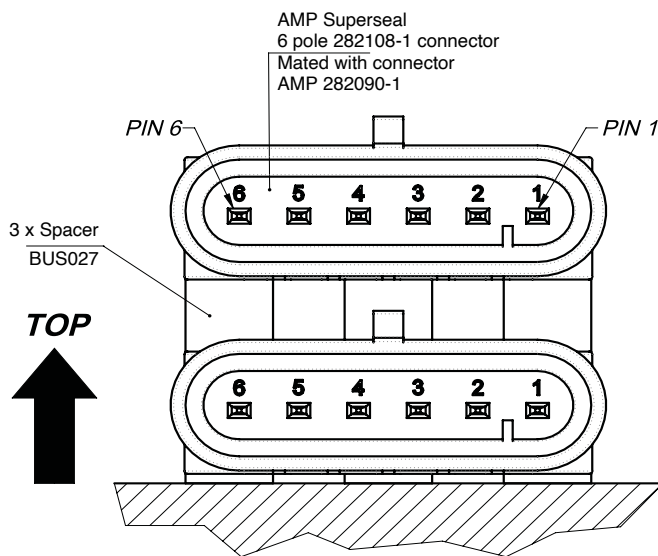
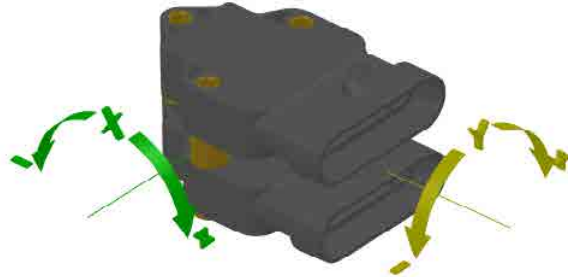

#### ANALOG CONNECTIONS DUAL AXIS X-Y

1. GROUND
2. + SUPPLY
3. OUTPUT X
4. OUTPUT Y
5. n.c.
6. n.c.

#### ANALOG CONNECTIONS SINGLE AXIS Z

1. GROUND
2. + SUPPLY
3. OUTPUT Z
4. n.c.
5. n.c.
6. n.c.

#### CAN CONNECTIONS SINGLE/DUAL AXIS

1. GROUND
2. + SUPPLY
3. n.c.
4. n.c.
5. CAN L
6. CAN H

**ITEMS MARKED "n.c." SHOULD NOT BE CONNECTED**

#### MECHANICAL DIMENSIONS

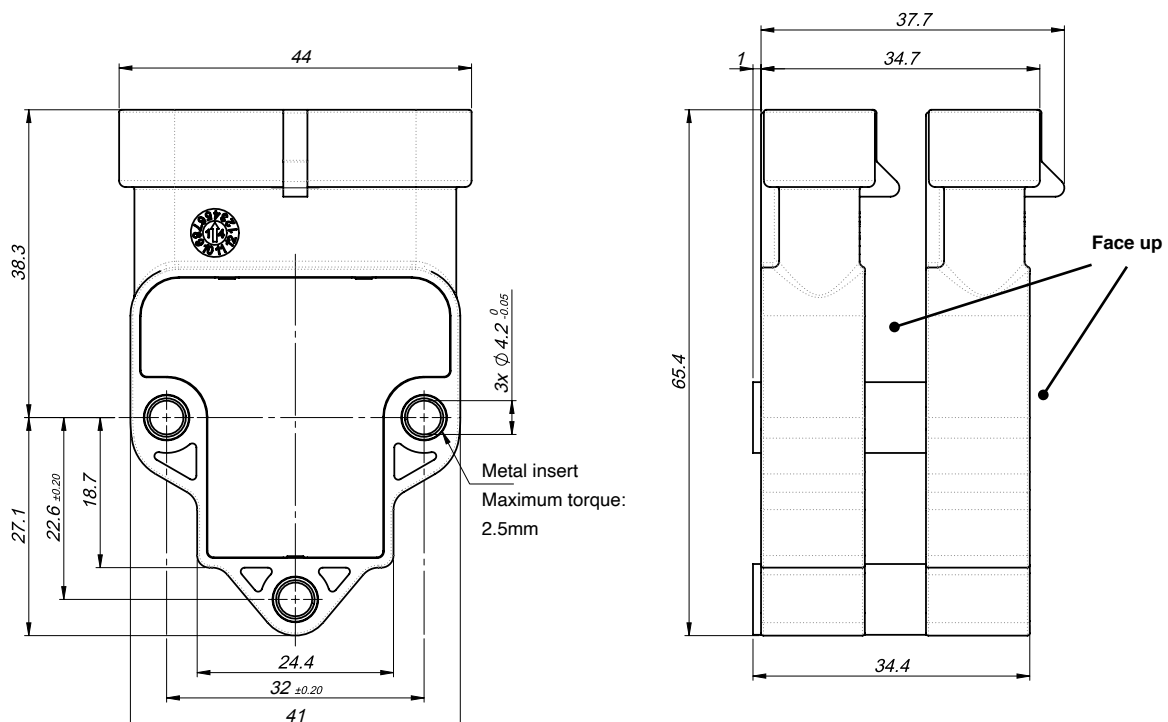

## AUTOZERO FUNCTION (additional function)

available for analog versions in GIB-XY configuration (dual axis)



To activate the **Autozero function** make sure that:

- sensor is powered
- fixing surface is free of dust or grease
- sensor is fixed on the horizontal plane with suitable screws



### ATTENTION!

The Autozero function can be defined **within a maximum range of +/- 4.5°** from the original zero position (factory set).

Hold the **magnetic pen** ① (accessory to order-PKIT312) to the **ZERO POINT**  indicated on the product label ②.

Hold the position for **at least 3-5 seconds** so that the operation is successful.

①



②



# FUNCTIONS: SENSOR OUTPUT GRAPH

DUAL AXIS TILT SENSOR (XY) - X AXIS

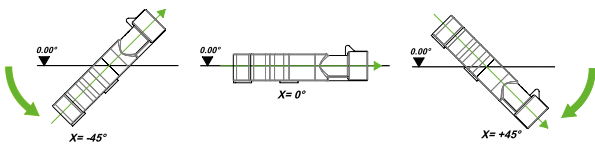
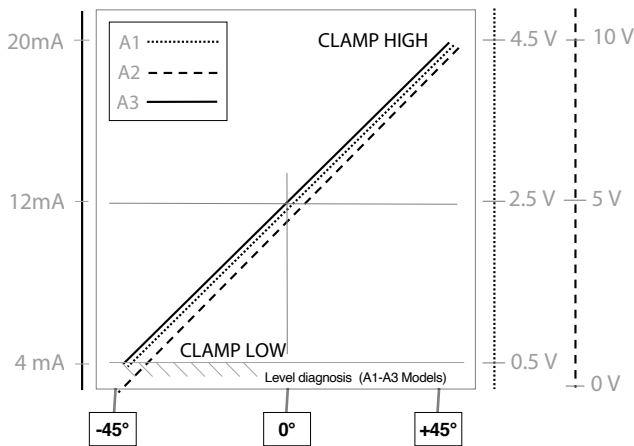

DUAL AXIS TILT SENSOR (XY) - Y AXIS

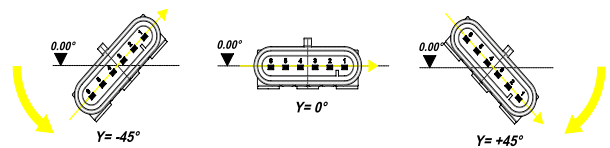
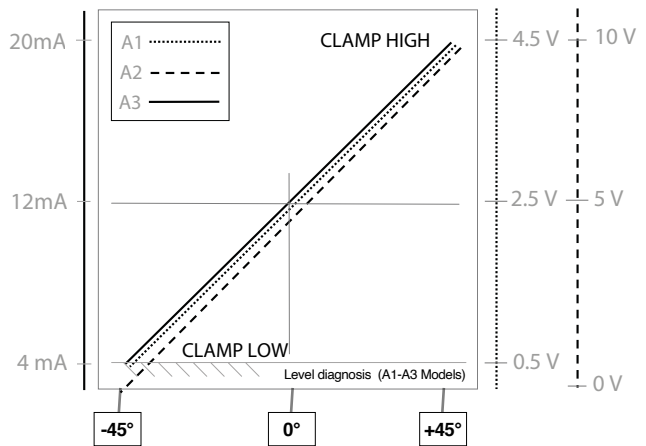

SINGLE AXIS TILT SENSOR ( $\pm 180^\circ$ ) - Z AXIS

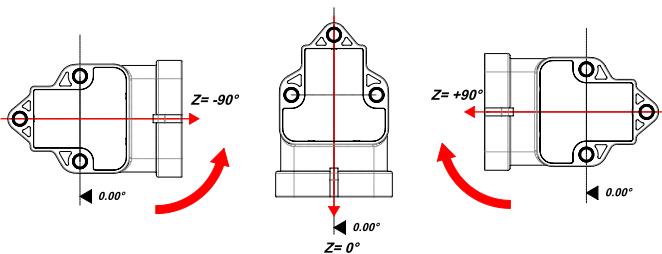
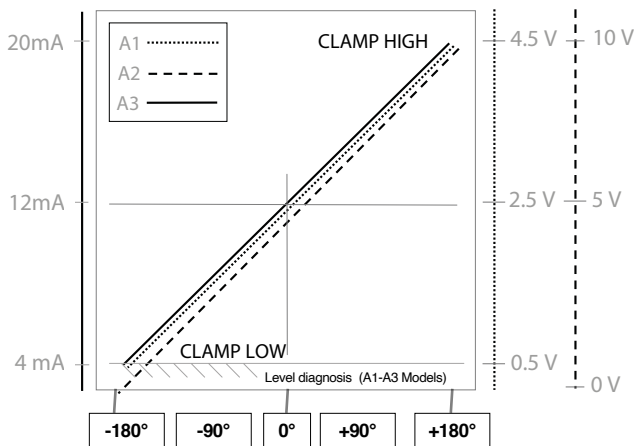

## LOAD CONDITIONS

+0.5Vdc...+4.5 Vdc output with power +10...36Vdc and +0..10Vdc output with power +11..36Vdc: it is recommended a load resistance > 100 kohm

+0.5Vdc...+4.5 Vdc output with power +5 Vdc: it is recommended a load resistance > 100 kohm

+4...20 mA output with power < 15Vdc up to 10Vdc: the maximum load resistance is admissible 200 ohm

+4...20 mA output with power > 15Vdc up to 36Vdc: the maximum load resistance is admissible 500 ohm

## ORDERING CODE

### GIB - SINGLE/DUAL AXIS ENTRY LEVEL TILT SENSOR (XY/360°)

ELECTRICAL CONNECTIONS	
AMP Superseal 6P connector output	<b>A</b>
Cable output (specify cable length)	<b>F</b>

AXIS TYPE	
Dual axis (XY axis)	<b>O</b>
Single axis (Z axis)	<b>V</b>

MEASURING RANGE	
measuring range (indicate) ±10° ±15° ±20° ±30° ±45° ±60° ±85° (single axis Z for analogue output-dual axis XY); 360° (±180°) for single Z axis only	<b>XXX</b>

MEASURING RANGE (NOT available)	
(redundant option NOT available)	<b>000</b>

SUPPLY VOLTAGE	
+5Vdc (only for A1 output)	<b>L</b>
+10...+36Vdc (see output signal for right supply voltage)	<b>H</b>

OUTPUT TYPE	
+0.5...+4.5Vdc output (available with supply L = ratiometric output and with supply H = 0.5...4.5Vdc output)	<b>A1</b>
0...+10Vdc output (powered at +11...+36Vdc)	<b>A2</b>
4...20mA output (powered at +10...+36Vdc)	<b>A3</b>
CANopen output (powered at +10...+36Vdc)	<b>C1</b>

CABLE	
Cable without connector (always "0" in case of GIB-A version)	<b>0</b>
Cable (100mm) + M12 5 pin male overprinted connector	<b>1</b>

CERTIFICATE	
<b>0</b>	No certificate attached
<b>L</b>	Linearity curve to be attached

ACCESSORIES	
<b>X</b>	No accessories
<b>Y</b>	Magnetic pen (PKIT312)
<b>A</b>	3x spacers for redundant version (BUS027)

CABLE LENGTH	
<b>01</b>	cable 100 mm
<b>02</b>	cable 200 mm
<b>05</b>	cable 500 mm
<b>10</b>	cable 1 m
<b>20</b>	cable 2 m
<b>---</b>	other lengths on request

#### EXAMPLE OF DESCRIPTION: GIBFV360000HA30 0000X01

<b>GIB</b>	<b>F</b>	<b>V</b>	<b>360</b>	<b>000</b>	<b>H</b>	<b>A3</b>	<b>0</b>	<b>0</b>	<b>000</b>	<b>X</b>	<b>01</b>
	cable output	single axis	360°	ND	+10...36Vdc	4...20mA output	cable only		special execution	no accessories	cable 100 mm
								no certificate attached			

GEFRAN spa reserves the right to make any kind of design or functional modification at any moment without prior notice