

MECHANICAL DIMENSIONS

Strokes from 50 to 1000 mm

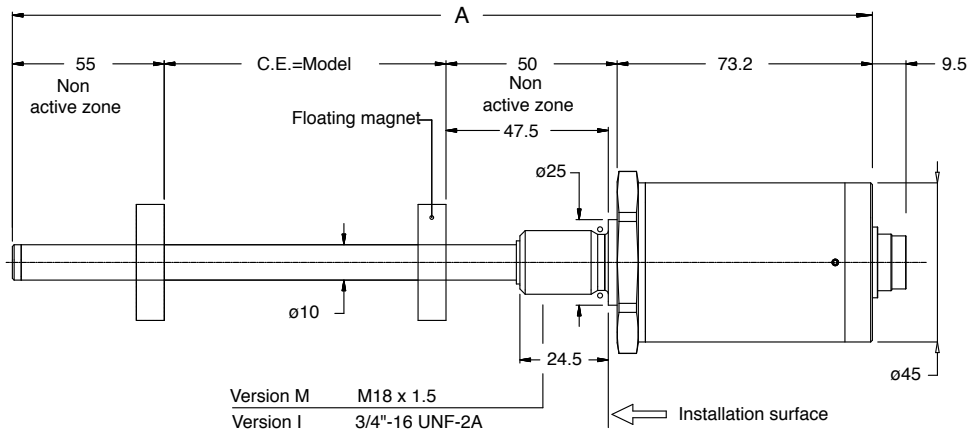

Strokes from 1250 to 1500 mm

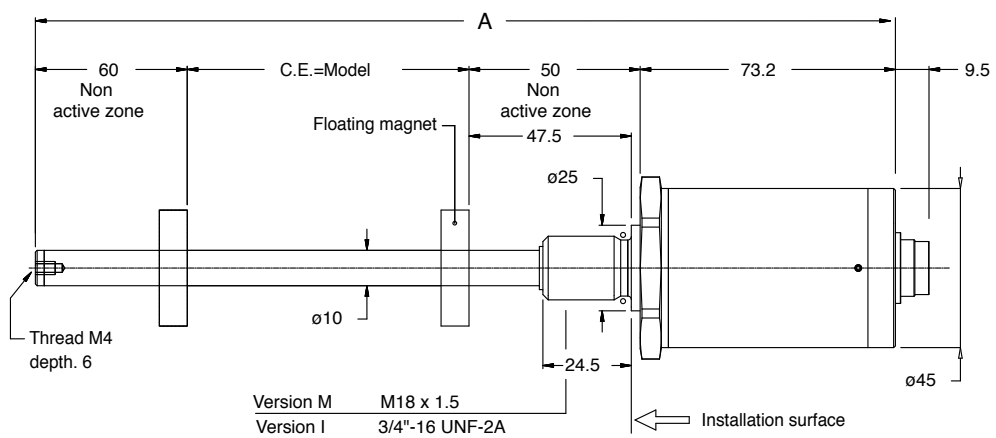

WRG-A-A/B connector output

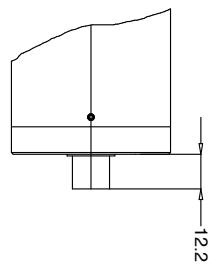

MOUNTING INSIDE A CYLINDER

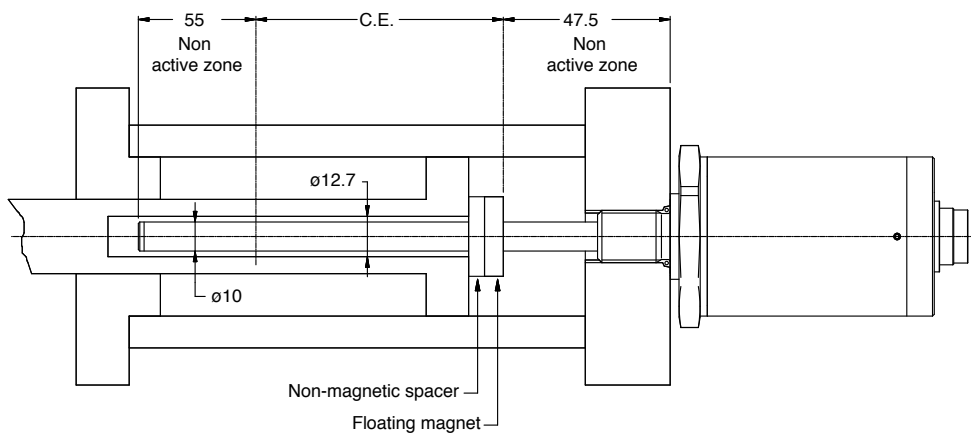

INSTALLATION INSIDE A CYLINDER

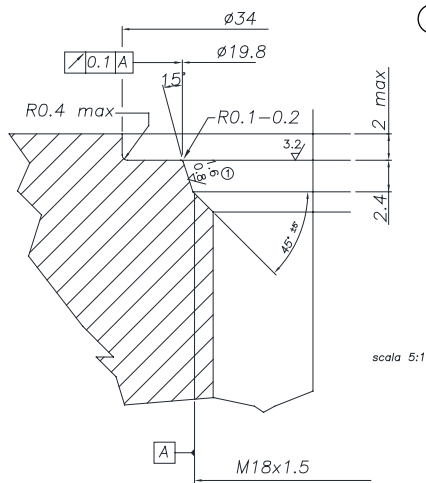

① THREAD M18x1,5

The sealing surface must be free from scratches longitudinal or spiral
 Ro 1.6 μm for sealing with NON-pulsating pressure
 Ro 0.8 μm for seals with pulsating pressure

Suggested o-ring:

PARKER 6-349 15,4x2,1
 Material: Viton 90° Shore-A
 Mixes: PARKER N552-90

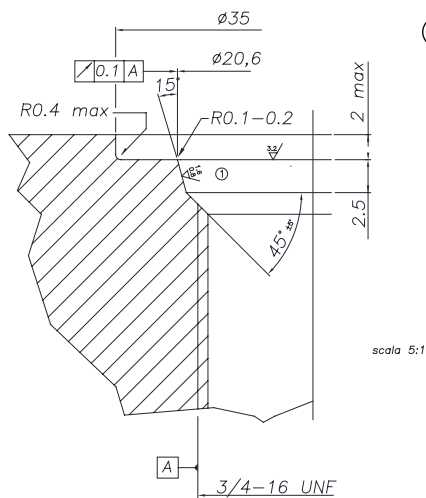
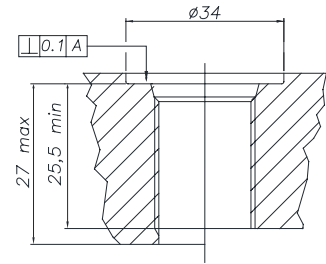

① THREAD 3/4"-16UNF

The sealing surface must be free from scratches longitudinal or spiral
 Ro 1.6 μm for sealing with NON-pulsating pressure
 Ro 0.8 μm for seals with pulsating pressure

Suggested o-ring:

PARKER 3-908 16,36x2,21
 Material: Viton 90° Shore-A
 Mixes: PARKER N552-90

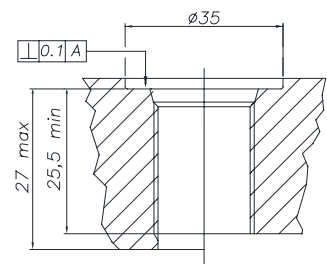

ELECTRICAL CONNECTIONS

Function	CONNECTORS	
	WRG-A-A	WRG-A-B
	5 pin M12	6 pin M16
Output 1 (position) 0...10V 4...20mA	1	1
GND Output 1 (0V)	2	2
Output 2 (inverse position) 10...0V 20...4mA	3	3
GND Output 2 (0V)	2	4
Power supply +	5	5
Power supply GND	4	6
n.c.	-	-
n.c.	-	-

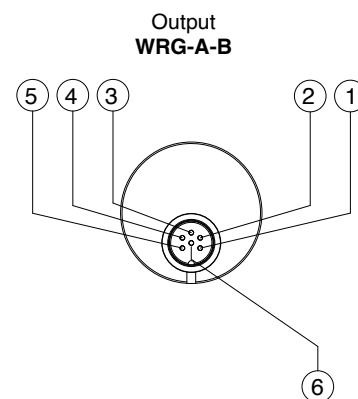
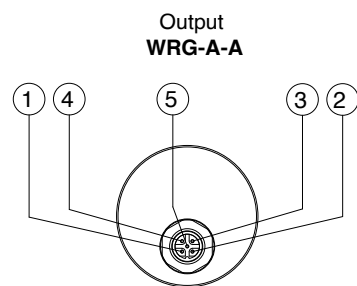

FLOATING CURSOR



Cursors	
Cursor Diameter 32.8	095
Cursor Diameter 32.8 with 90° slit	096
Cursor Diameter 25.4	097
Floating cursor for liquids with hole diameter 12	098

The **PCUR095** is supplied with:
 N° 8 Brass nuts M4
 N° 8 Brass washers D4
 N° 4 Brass screws M4x25

The **PCUR096** is supplied with:
 N° 4 Brass nuts M4
 N° 4 Brass washers D4
 N° 2 Brass screws M4x25

Dimensions	A	B	C	D	Thickness
PCUR095	32.8	13.5	23.9	-	7.9
PCUR096				11	
PCUR097	25.4	13.5		-	

Model	PCUR098	
Length A	mm	52.4
Diameter B (hole)	mm	12
Diameter C	mm	44
Material		AISI 316

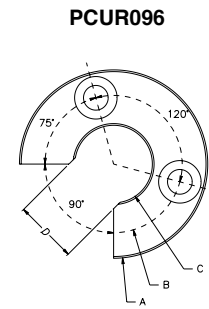
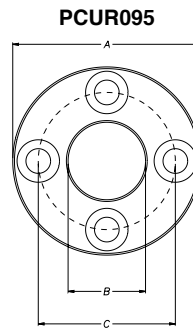

PCUR097

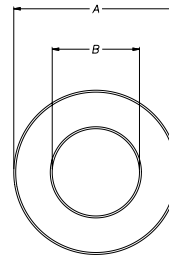

HEIGHT DETECTION POSITION

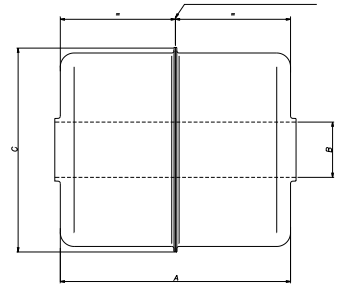

Note: **PCUR098** is supplied with kit **PKIT036** for floating cursor for liquids.

OPTIONAL CONNECTORS (to order separately)

For **WRG-A-A**, M12 thread connector
 CON031 and CON041 for 5 pin output (WRG-A-A)

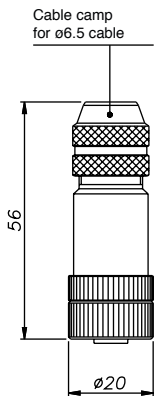

CON031
IP67 - IEC 48B

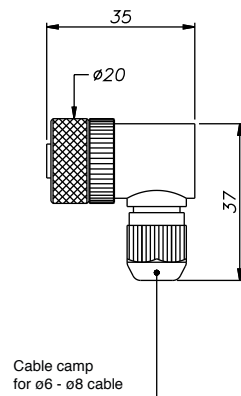

CON041
IP67

For **WRG-A-B**, M16 thread connector
 CON021, CON022 and CON023 for 6 pin output (WRG-A-B)

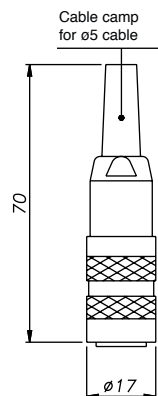

CON021
IP40 - EMC

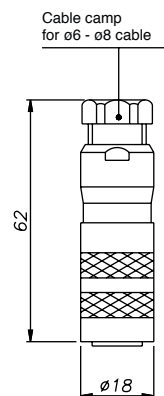

CON022
IP67 - EMC

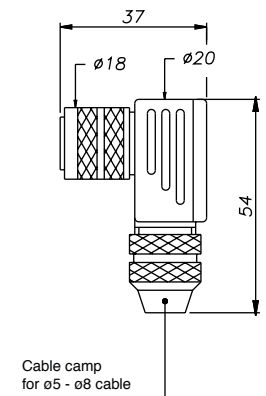

CON023
IP67 - EMC

OPTIONAL OUTPUT CABLES (to order separately)

For **WRG-A-A**, cable with connector (straight or 90°) with M12 thread 5 pin

Length "L"		CODE	
		Straight cable	Cable to 90°
2	mt	CAV011	CAV021
5	mt	CAV012	CAV022
10	mt	CAV013	CAV023
15	mt	CAV015	CAV024

ACCESSORIES (to order separately)

Non-magnetic spacer for mounting PCUR022 cursor

CUR022

Sensors are manufactured in compliance with:

- EMC 2014/30/EU compatibility directive
- RoHS 2011/65/EU

Electrical installation requirements and Conformity certificate are available on our web site: www.gefran.com