

ISOSCAN-H



96(H) x 192(W) x 220(D) mm

ISOSCAN-V



192(H) x 96(W) x 220(D) mm

FLAMEPROOF



rSCADA

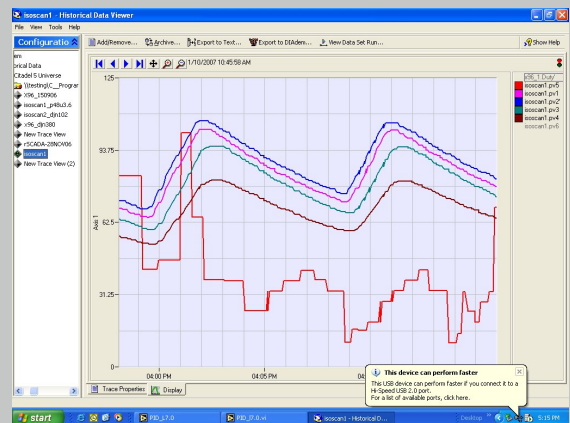

- Upto 16 inputs/16 outputs
- For Temperature, Pressure, Flow, Level, RH, Conductivity, etc.
- Various Input (X)/Output (Y) combinations : X4Y0, X4Y8, X8Y4, X8Y16, X16Y16, etc
- Universal Input : 8 Thermocouples, Pt100, mV or mA input front panel selection without DIP **for each channel**
- Front panel user calibration
- Input burn protection
- Non-volatile memory for parameters - no batteries

- 3 key, 5 level programming
- Setpoint and level locks
- Tactile membrane keypad
- 5 software versions : Indicator, Multisetpoint, Grouping, etc
- RS485 with MODBUS RTU
- Powerful, flexible SCADA software available
- FDA21CFR Part11 compliant SCADA version also
- Option : Printer interface (no computer needed)
- 85~265 V AC SMPS or 24 V DC supply

TABLE 1 : SOFTWARE VERSIONS

| VERSION NO. | | | VERSION NAME | DESCRIPTION |
|-----------------------------------|--|--|---|--|
| WITHOUT RS485 & PRINTER INTERFACE | WITHOUT RS485 & WITH PRINTER INTERFACE | WITH RS485 & WITHOUT PRINTER INTERFACE | | |
| 10.XX | 40.XX | 50.XX | Indicator | No alarms/relays |
| 11.XX | 41.XX | 51.XX | Basic | Setpoint 1 corresponds to channel 1, setpoint 2 to channel 2, etc. |
| 12.XX | 42.XX | 52.XX | Multisetpoint | Upto 16 setpoints can be assigned to any channel (total setpoints for all channels : 16 or less) |
| 13.XX | - | 53.XX | Grouping/Common alarms | The 16 channels can be grouped into 16 groups, each group comprising 1 to 16 channels. Upto 16 setpoints can be assigned to each group (total setpoints for all groups : 16 or less) |
| 18.XX | - | 58.XX | Grouping/Individual alarms/ Common relays | Grouping with 2 alarms per group, individual setpoints for each channel for each group alarm and 1 relay for each group alarm. |

BASIC VERSIONS 11, 41, 51

Fig 1

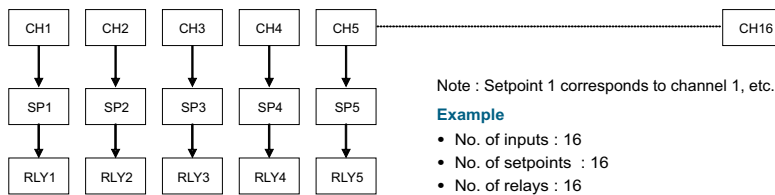

Note : Setpoint 1 corresponds to channel 1, etc.

Example

- No. of inputs : 16
- No. of setpoints : 16
- No. of relays : 16

| Maximum No. | |
|-------------|----|
| Channels | 16 |
| Setpoints | 16 |
| Relays | 16 |

MULTISETPOINT VERSIONS 12, 42, 52

Fig 2

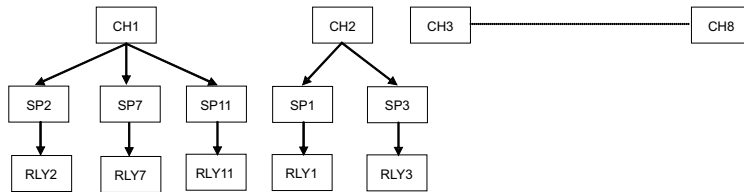

Note : More than one setpoint can be assigned to one channel.

Example

- No. of channels : 16
- No. of setpoints assignable to each channel : 16 or less
- No. of relays : 16
- Channels / assigned setpoints to each channel : See Table 2

TABLE 2

| Channel No. | Assigned Setpoints/Relays | Channel No. | Assigned Setpoints/Relays |
|-------------|---------------------------|-------------|---------------------------|
| 1 | 2, 7, 11 | 9 | 14 |
| 2 | 1, 3 | 10 | - |
| 3 | 12, 16 | 11 | - |
| 4 | 13 | 12 | - |
| 5 | 4, 5 | 13 | - |
| 6 | 6 | 14 | - |
| 7 | 10, 15 | 15 | - |
| 8 | 8, 9 | 16 | - |

| Maximum No. | |
|-------------------------|----|
| Channels | 16 |
| Setpoints for 1 channel | 16 |
| Setpoints in all | 16 |
| Relays | 16 |

GROUPING / COMMON ALARM VERSIONS 13, 53

Fig 3

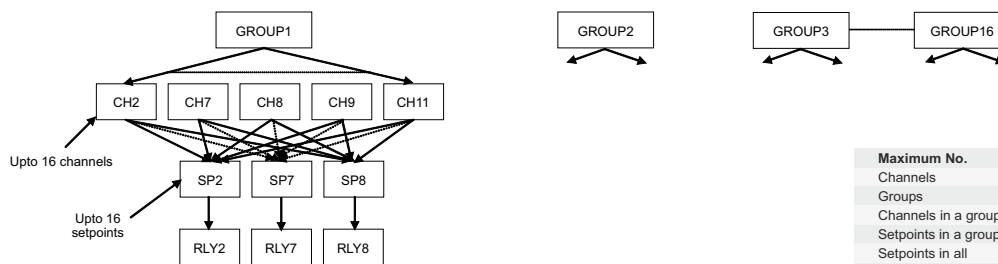

Note : Any channel can be selected in several groups. Upto 16 groups can be made.

Example

- No. of inputs : 16 • Input type / unit / resolution : See Table 4
- No. of groups : 16 • No. of relays : 16
- Channels / relays / relay logic in each group : See Table 3
- While grouping any channel, unit & display resolution of that channel & group level should be same.

TABLE 3

| Group No. | Channels Selected | Setpoint Selected | Relay No. |
|-----------|-------------------|-------------------|-----------|
| 1 | 2, 7, 8, 9, 11 | 2, 7, 8 | 2, 7, 8 |
| 2 | 8, 9, 11, 13 | 1, 9, 11 | 1, 9, 11 |
| 1 | 1, 4, 6 | 3 | 3 |
| 2 | 4, 5, 6 | 4 | 4 |
| 1 | 10, 12 | 5, 6 | 5, 6 |
| 2 | 3, 14, 15, 16 | 10, 12 | 10, 12 |
| 1 | 14, 16 | 13, 15 | 13, 15 |
| 2 | 3, 14 | 14, 16 | 14, 16 |

TABLE 4

| Channel No. | Input type | Unit | Resolution |
|-------------|-----------------|------|------------|
| 1 | TC B | °C | 0.1 |
| 2 | TC E | °F | 1 |
| 3 | TC J | °K | 0.1 |
| 4 | TC K | °C | 0.1 |
| 5 | TC N | °C | 0.1 |
| 6 | TC R | °C | 0.1 |
| 7 | TC S | °F | 1 |
| 8 | TC T | °F | 1 |
| 9 | Pt100 | °F | 1 |
| 10 | LIN V (0-50 mV) | BAR | 0.001 |
| 11 | 0-20 mA | °F | 1 |
| 12 | 4-20 mA | BAR | 0.001 |
| 13 | Pt100 | °F | 1 |
| 14 | TC N | °K | 0.1 |
| 15 | TC J | °K | 0.1 |
| 16 | TC K | °K | 0.1 |

| Maximum No. | |
|----------------------|----|
| Channels | 16 |
| Groups | 16 |
| Channels in a group | 16 |
| Setpoints in a group | 16 |
| Setpoints in all | 16 |
| Relays | 16 |

GROUPING / INDIVIDUAL ALARMS / COMMON RELAYS VERSIONS 18, 58

Fig 4

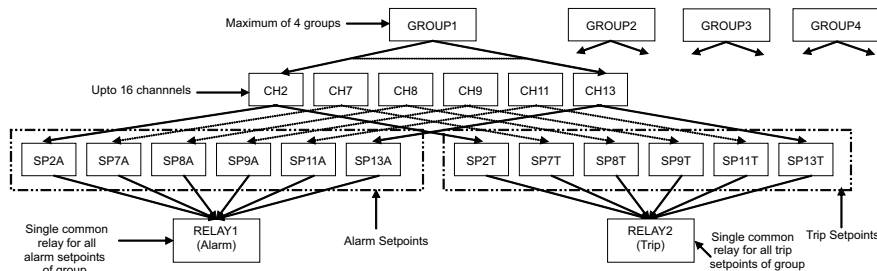

| Maximum No. | |
|----------------------|----|
| Channels | 16 |
| Groups | 4 |
| Channels in a group | 16 |
| Setpoints in a group | 32 |
| Setpoints in all | 32 |
| Relays | 8 |

Note : Once a channel is selected in one group, you cannot select it in another group.

Example

- No. of channels : 16 • Input type / unit / resolution : See Table 6
- No. of groups : 4 • No. of relays : 8
- Channels / relays / relay logic in each group : See Table 5

TABLE 5

| Group No. | Channels Selected | Relay No. | Relay Logic |
|-----------|--------------------|-----------------------|-----------------|
| 1 | 2, 7, 8, 9, 11, 13 | 1 (alarm) 2 (trip) | Lo Trip |
| 2 | 3, 14, 16 | 3 (alarm) 4 (trip) | Hi Trip Lo |
| 3 | 10, 12 | 5 (alarm) 6 (trip) | HiHi Trip |
| 4 | 1, 4, 5, 6, 15 | 7 (alarm) 8 (trip) | LoLo Trip Lo |

TABLE 6

| Channel No. | Input type | Unit | Resolution |
|-------------|-----------------|------|------------|
| 1 | TC B | °C | 0.1 |
| 2 | TC E | °F | 1 |
| 3 | TC J | °K | 0.1 |
| 4 | TC K | °C | 0.1 |
| 5 | TC N | °C | 0.1 |
| 6 | TC R | °C | 1 |
| 7 | TC S | °F | 1 |
| 8 | TC T | °F | 0.1 |
| 9 | Pt100 | °F | 0.1 |
| 10 | LIN V (0-50 mV) | BAR | 0.01 |
| 11 | 0-20 mA | °F | 0.001 |
| 12 | 4-20 mA | BAR | 0.1 |
| 13 | Pt100 | °F | 1 |
| 14 | TC N | °K | 1 |
| 15 | TC J | °K | 0.1 |
| 16 | TC K | °K | 0.1 |

SPECIFICATIONS

Specifications & features are subject to change without notice.

INPUTS

Maximum no. of channels (X) 16
Input types
 Thermocouple B, E, J, K, N, R, S, T
 RTD Pt100, 3-wire
 Linear input 0-50 mV, 0-20 mA, 4-20 mA
 (each input independently scalable and without any DIP reconfiguration) < 1.6 seconds for 16 channels
Channel scan rate
Channel-to-channel isolation Suitable for low (leakage) voltages less than 3V AC
Input protection
 Thermocouple, mV, RTD inputs ± 10 V DC max
 Current inputs Current limit < 30 mA, 28 V DC max
Range limits See Table 7
Accuracy See Table 7
Cold junction compensation Automatic
Sensor break protection User programmable

CONTROL

Control functions (Diagram 1)
 ON/OFF control Heat or Cool or Cool with compressor time delay (version 11.XX, 41.XX & 51.XX)
Alarm functions
 High alarm
 Low alarm
 Deviation high alarm
 Deviation low alarm
 Inband alarm
 Outband alarm
Control action Direct / reverse
Hysteresis 0.1 - 99.9 °C / °F / EU
Compressor ON time delay 1 - 200 sec
Alarm type
 Autoreset, Latch, Hold, Latch + Hold
 Latch (Ltch) Once relay gets ON, it remains 'ON' until alarm is acknowledged by ▲ key.
 Hold Alarm is disabled at power ON. After process variable reaches normal (non alarm) value, the alarm is enabled.
 Ltch.Hold Combination of Latch & Hold logic.

OUTPUTS

Maximum no. of outputs (Y) 16 (8 inbuilt, 8 in external relay unit)
Output type
 a) Electromagnetic relay
 b) SSR drive
Relay contact type NO-C
Relay contact rating 5A / 230V AC, resistive

ADJUSTMENTS

Setpoint Full range adjustable
Alarm Full range adjustable
Unit User selectable
Resolution User selectable
 0.0001, 0.001, 0.01, 0.1 or 1 for linear input, 0.1 or 1 for temperature

OTHER MAJOR PARAMETERS

Setpoint lock
Level lock
Display scan rate 1-99 seconds/channel
SKIP channel Enable/disable
Display channel Display/Hide

COMMUNICATION

Port RS485, isolated
Baud rate 9600 bps
Protocol Modbus RTU
Slave ID User programmable, 1-255
Minimum polling interval 250 milliseconds
Parameters
 Process variables Read only
 Setpoints Read & write from the host computer
 Alarm status Read only
 Relay status Read only
CALIBRATION
Zero & span
User calibration
CJC calibration
INDICATION
Display type 0.56" (15 mm), 7 - segment LED and 2x16 character LCD display
 Upper, 4 ½ digit, LED display
 Middle, 4 ½ digit, LED display
 Lower, 2 digit, LED display
 16 LEDs for alarm, 16 LEDs for relay status & 2x16 LCD
Process variable
Setpoint
Channel no.
Status indication
OTHER
Keypad Membrane, tactile, 3 keys
Memory for programmed parameters Non-volatile, indefinite duration
Field Connections Screw type connections in plug-in terminals
Plug-in Terminal Type a) Standard (Brass nickel plated)
 b) Gold plated
Supply voltage a) 85-265 V AC, 50/60 hz
 b) 24 V DC supply
Power consumption 5 watts
Dimensions (in mm)
 ISOSCAN-H 96(H)x192(W)x220(D)
 ISOSCAN-V 192(H)x96(W)x220(D)
 FLP ISOSCAN X8Y8 & below : 420(H)x365(W)x165(D)
 X12Y0 & above : 500(H)x365(W)x165(D)
Mounting
 ISOSCAN-H In panel cutout of 90x186 mm
 ISOSCAN-V In panel cutout of 186x90 mm
 FLP ISOSCAN Surface
FLP enclosure Certified flameproof for gas groups I, IIA & IIB
 IP55
Protection (FLP enclosure)
Operating ambient temperature 0 - 50 °C
Relative humidity Below 90%, non condensing
EXTERNAL RELAY UNIT
Dimensions 75(H)x100(W)x110(D)
Mounting Snap on for 35mm DIN rail to DIN 46277
PRINTER INTERFACE
Dimensions (in mm) 96(H)x96(W)x120(D)
Mounting In panel cutout of 92x92 mm
Connection 25 pin male D type connector
Printer type Epson LX-300, LX-300+, EPSON LX-800
Printer type Dot Matrix

TABLE 7

| SENSOR / INPUT | RANGE LIMITS (°C / EU) | | RANGE IN WHICH ACCURACY IS SPECIFIED | | TYPICAL ACCURACY AT 30 °C (°C / EU) | WORST CASE ACCURACY (°C / EU) |
|------------------------------------|------------------------|------------|--------------------------------------|------------|-------------------------------------|-------------------------------|
| | LOW SCALE | HIGH SCALE | LOW SCALE | HIGH SCALE | | |
| Pt - 6% Rh / Pt - 30% RH (B) | 400 | 1820 | 400 | 1820 | ± 3 | ± 5 |
| Chromel / Constantan (E) | -270 | 1000 | 0 | 1000 | ± 1 | ± 3 |
| Iron / Constantan (J) | -210 | 760 | 0 | 760 | ± 1 | ± 3 |
| Chromel / Alumel (K) | -270 | 1372 | -50 | 1200 | ± 1 | ± 3 |
| Nicrosil / Nisil (N) | -270 | 1300 | -50 | 1200 | ± 1 | ± 3 |
| Pt / Pt - 13% Rh (R) | 0 | 1760 | 0 | 1760 | ± 2 | ± 5 |
| Pt / Pt - 10% Rh (S) | 0 | 1760 | 0 | 1760 | ± 2 | ± 5 |
| Copper / Constantan (T) | -270 | 400 | -200 | 400 | ± 1 | ± 3 |
| Pt100, 3-wire | -200 | 850 | -200 | 850 | ± 0.5 | ± 2.0 |
| Linear (0~50 mV, 0~20 mA, 4~20 mA) | -19999 | 19999 | -19999 | 19999 | ± 5 EU | ± 20 EU |

DIAGRAM 1

CONTROL FUNCTIONS

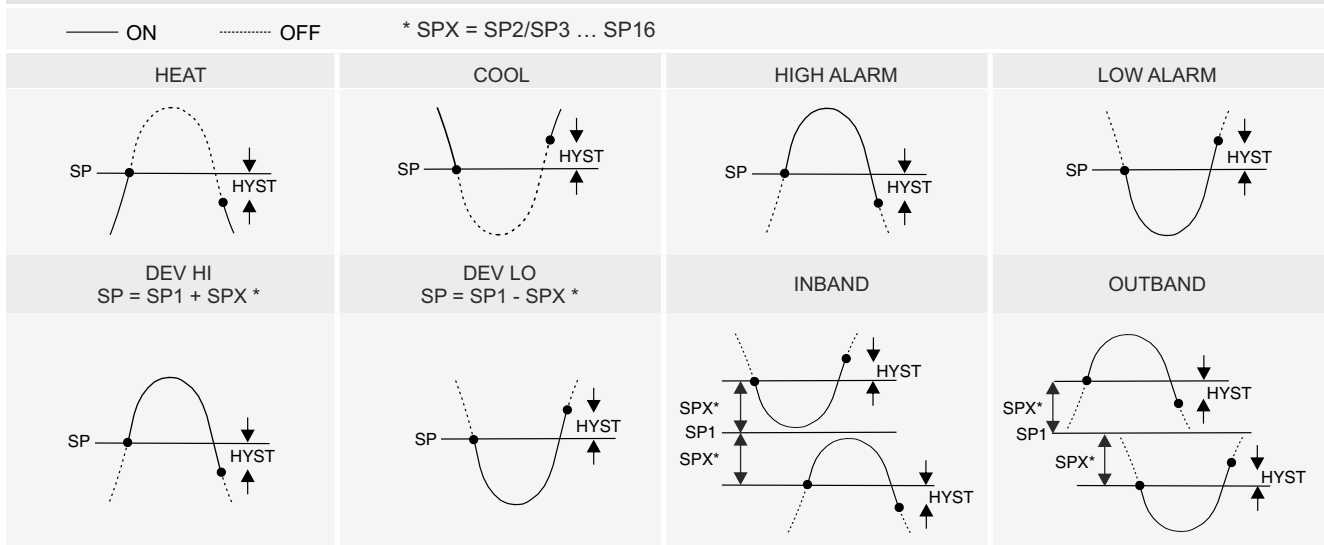

ORDERING INFORMATION

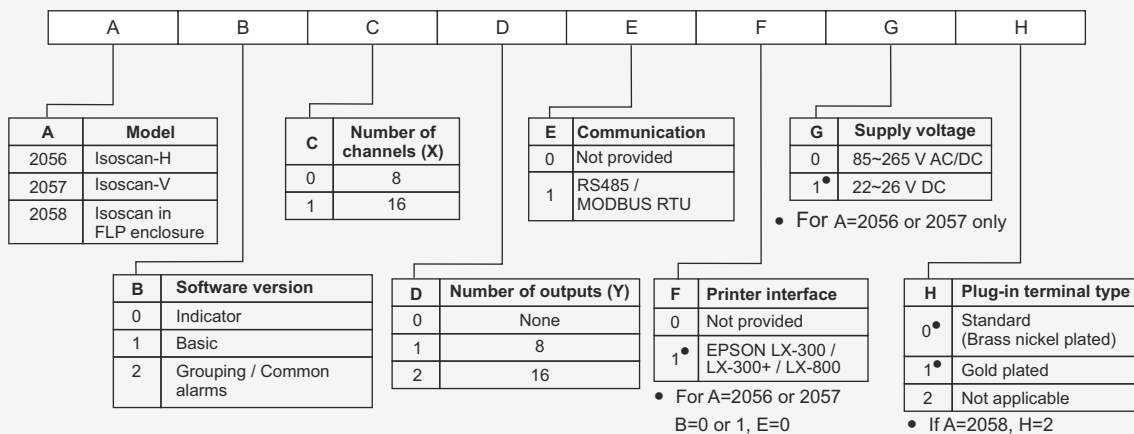

Ordering Options

The following ordering options are available on request. Minimum order quantity and/or minimum order value may apply.

| | Option | Details |
|----|------------------|--|
| 1. | Software version | Multisetpoint |
| 2. | Software version | Grouping / Individual Alarms / Common Relays |